

**FLOOD
LIGHT** 50
Projektør



Art. no 6232

TEKNISKE DATA

Watt	50 Watt	
Drift strøm	0.24A	
Start strøm	53A	
Lumen	3500 Lm	
Lumen per watt	70 Lm/Watt	
Flux 90 ° vinkel	3050 Lm	
Flux 120 ° vinkel	3200 Lm	
Spredningsvinkel	90 grader	
Candela	2,640 Candela	
Kelvin	4200 Kelvin	
Farvegengivelsesindeks	RA>70	
Energi klasse	A	
Levetid i timer (L70)	30.000 timer	
Tænd/sluk - antal	15.000 gange	
Starttid til 60% af fuld lumen	Straks	
Kan lampe dæmpes	Nej	
Svarende til glødepære watt	250 Watt	
Vægt	3,9kg	
Lampe mål mm	396mm X 328mm X 107mm	
Tæthedsklasse	IP44	
Max vind overflade	0.115m ²	
Indbygget transientbeskyttelse	F/N	F/J - N/J
KV	1,0kV	2,0kV

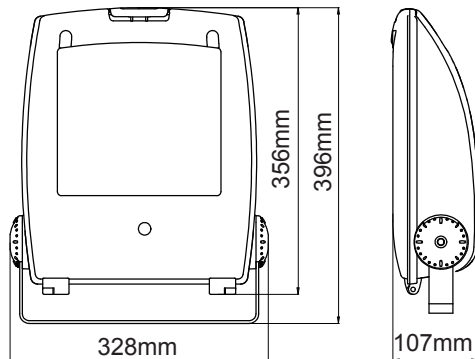

FLUX KURVE

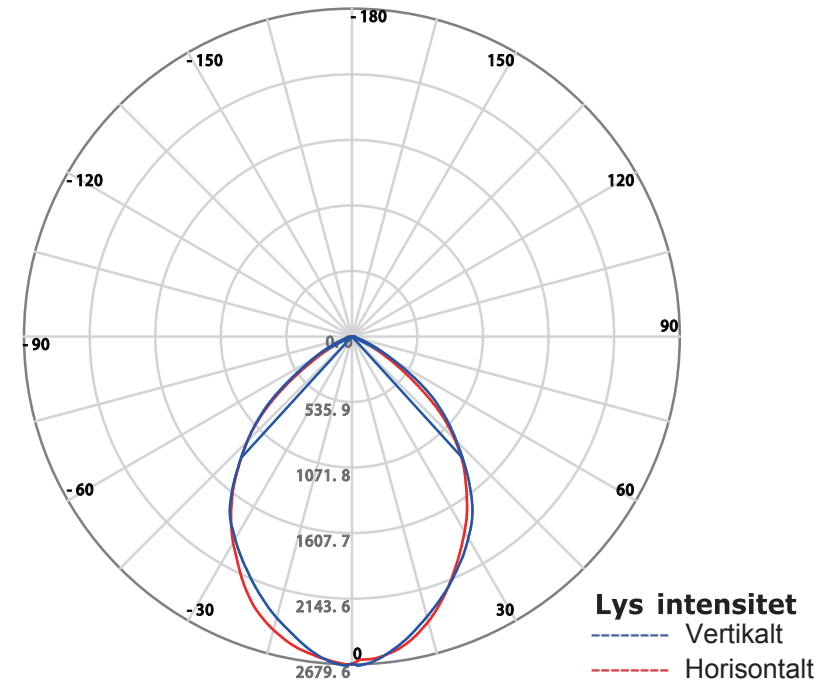

FLUX DIAGRAM

